

VectorStar™

Multiport, High Performance, Broadband Network Analysis Solutions

MN469xB Series

Vector Network Analyzer Multiport Test Sets

Introduction

This document provides the specifications for the MN469xB series Multiport Vector Network Analyzers (VNAs) test sets listed below, when used in conjunction with the 2-port MS4640A series VectorStar VNA. These MN469xB specifications are based upon the MS4640A series VNA specifications, which can be found at www.us.anritsu.com/vectorstar. They will be referenced throughout this document.

Test Set Models:

MN4694B 4-port, K (2.92 mm), 70 kHz* to 20/40 GHz

MN4697B 4-port, V (1.85 mm), 70 kHz* to 50/70 GHz

*Operational to 40 kHz

Minimum MS4640A Series 2-port VNA Configuration required: MS4640A VNA with Option 051, Direct Access Loops

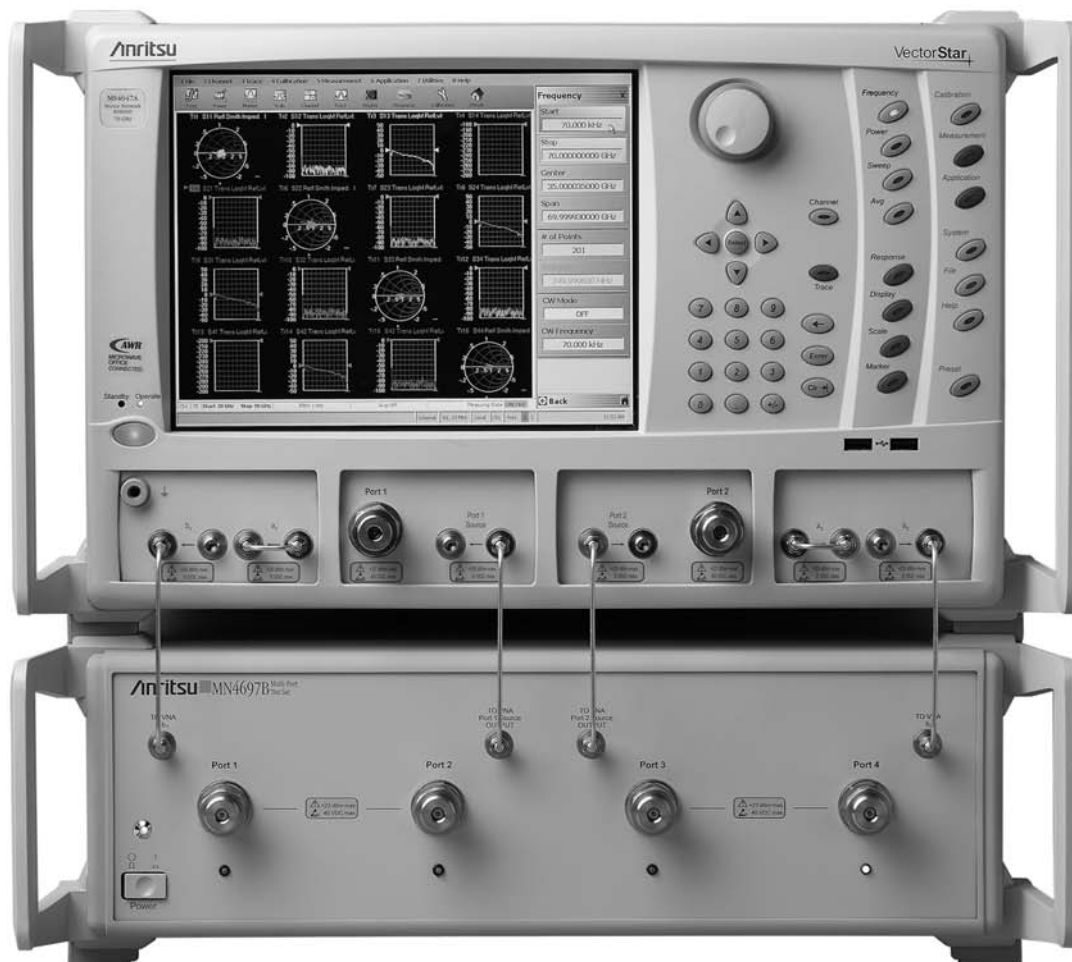

Table of Content

Description	Page
1. Definitions	2
2. System Block Diagram.....	3
3. System Performance.....	4
3.1 Test Port Power, Noise Floor, System Dynamic Range	4
3.2 Receiver Compression, Receiver Dynamic Range	4
3.3 High Level Noise	4
3.4 Measurement Stability	5
3.5 Phase Noise, Harmonics, Non-Harmonics (Spurious)	5
3.6 Uncorrected (Raw) Port Characteristics	5
3.7 Corrected System Performance and Uncertainties	6
3.8 Measurement Time	10
4. Remote Operability	10
5. Capabilities and Calibrations added to the base 2-port VNA	10
6. Optional Capabilities	10
7. Front Panel Connections	11
8. Rear Panel Connections	12
9. Mechanical and Environmental	13
10. Warranty	13
11. Ordering Information.....	13
12. Configuration Guide	14

1. Definitions

All specifications and characteristics apply under the following conditions, unless otherwise stated:

- After 90 minutes of warm-up time, where the instruments is left in the ON state.
- Over the 25 °C ± 5 °C temperature range.
- For error-corrected specifications, over 23 °C ± 3 °C, with < 1 °C variation from calibration temperature.
- For error-corrected specifications are warranted and include guard-bands, unless otherwise stated.
- Specifications do not include effects of any user cables attached to the instrument.
- Specifications may exclude discrete spurious responses.
- All specifications apply with internal 10 MHz Crystal Oscillator Reference Signal.
- All specifications subject to change without notice. For the most current data sheet, please visit the Anritsu website: www.us.anritsu.com
- Typical performance indicates the measured performance of an average unit. It does not include guard-bands and is not covered by the product warranty. Typical specifications are shown in parenthesis, such as (-102 dB), or noted as Typical.
- Characteristic performance indicates a performance designed-in and verified during the design phase. It does include guard-bands and is not covered by the product warranty.
- All uncertainties below 300 kHz are typical.
- Recommended Calibration Cycle: 12 months
- All specifications are with Interpolation Mode Off

2. System Block Diagram

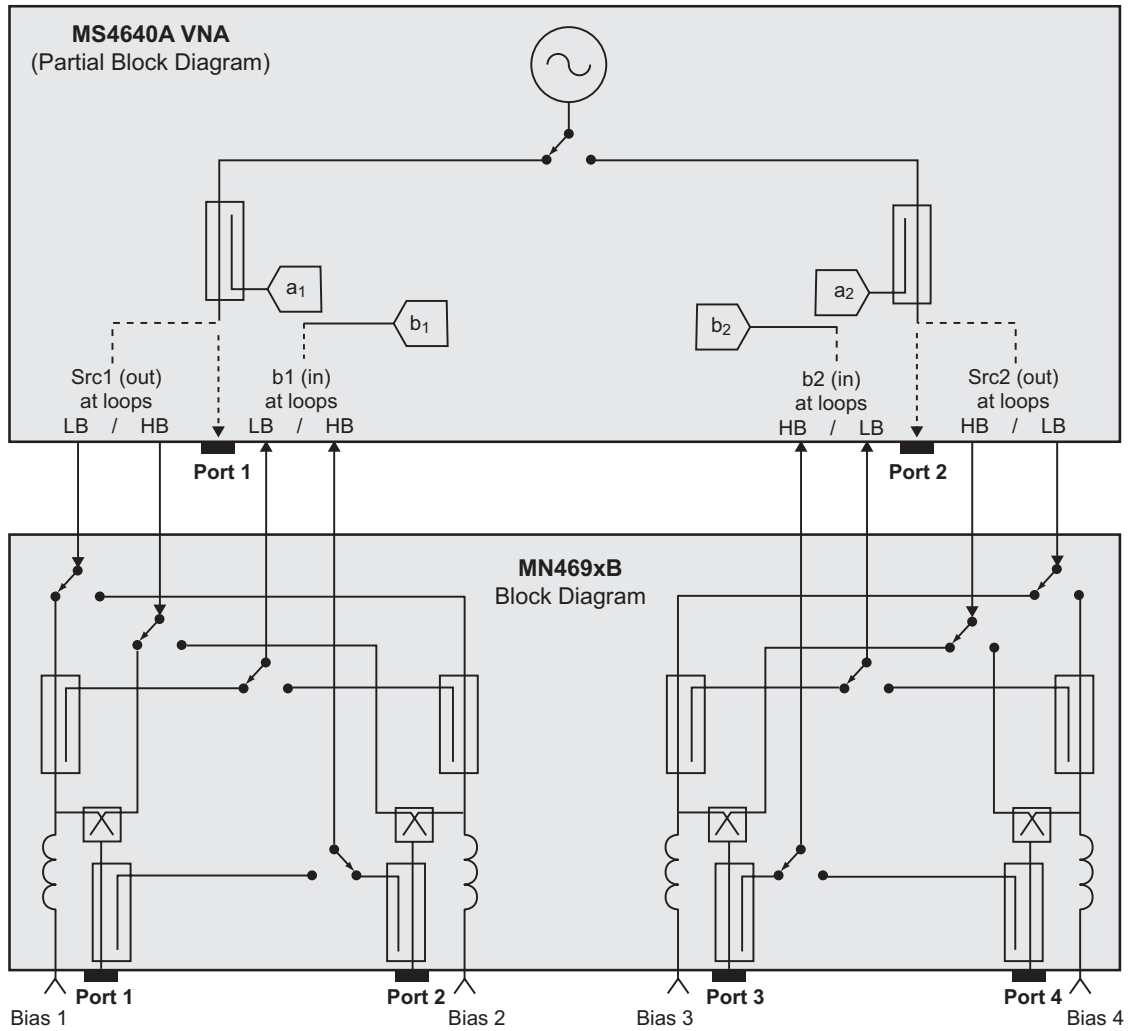

3. System Performance

System performance is specified when connected to a base 2-port VNA with option 051 (Direct Access Loops). If additional options are added to the base VNA that affect its port performance, those effects must also be added to these system specifications. Specifically, adding option 06x, Active Measurement Suites will affect available test port power and dynamic range.

The MN469xB series test sets only contribute loss to the source and test paths, and uncorrected (raw) port directivity and match. Therefore, a limited set of system performance parameters are shown below as specifications verified on each system. All other parameters are listed as Characteristic Performance. They are tested and verified during the design phase. Some of these parameters are solely a contribution of the base VNA and not affected by the test set.

3.1 Test Port Power, Noise Floor, System Dynamic Range

MN4694B with MS4642A or MS4644A, 20 or 40 GHz Models

Frequency Range	Power (dBm)	Noise Floor* (dBm)	System Dynamic Range**(dB)
0.07 to 2 MHz	+4	-72	76
2 to 10 MHz	+6	-94	100
0.01 to 2.5 GHz	+6	-100	106
2.5 to 40 GHz	+2	-98	100

MN4697B with MS4645A or MS4647A, 50 or 70 GHz Models

Frequency Range	Power (dBm)	Noise Floor* (dBm)	System Dynamic Range**(dB)
0.07 to 2 MHz	+4	-72	76
2 to 10 MHz	+6	-94	100
0.01 to 2.5 GHz	+6	-100	106
2.5 to 40 GHz	-3	-98	95
40 to 50 GHz	-7	-95	88
50 to 65 GHz	-13	-92	79
65 to 70 GHz	-20	-86	66

* Measured at 10 Hz IF bandwidth with no averaging, and at -10 dBm power setting. RMS. Leakage correction applied below 200 MHz.

Measurement made with a through line connection, with its effects compensated for.

** Calculated as the difference between the maximum test port power and the specified Noise Floor.

3.2 Receiver Compression, Receiver Dynamic Range

All Models

Frequency Range	Receiver 0.1 dB Compression* (dBm)	Receiver Dynamic Range** (dB)
0.07 to 0.5 MHz	+5	77
0.5 to 2 MHz	+10	85
2 to 10 MHz	+13	107
0.01 to 2.5 GHz	+13	113
2.5 to 20 GHz	+14	112
20 to 40 GHz	+15	113
40 to 50 GHz	+15	110
50 to 65 GHz	+15	107
65 to 70 GHz	+15	101

* Port power level beyond which the response may be compressed more than 0.1 dB relative to the normalization level (0.17 dB <300 kHz).

10 Hz IFBW used to remove any trace noise effects. Match Not included. Performance is Characteristic.

** Calculated as the difference between the maximum receiver input level for 0.1 dB compression and the specified noise floor. Performance is Characteristic.

3.3 High Level Noise

Measures at 1 kHz IFBW, at default power, with either full reflects or through transmission. RMS. Performance is characteristic.

Frequency Range	MN4694B		MN4696B	
	Magnitude (dB)	Phase (degree)	Magnitude (dB)	Phase (degree)
0.07 to 0.5 MHz	0.040	0.40	0.040	0.40
0.5 MHz to 40 GHz	0.005	0.05	0.006	0.06
40 to 50 GHz	n/a	n/a	0.007	0.07
50 to 65 GHz	n/a	n/a	0.008	0.08
65 to 70 GHz	n/a	n/a	0.030	0.30

3.4 Measurement Stability

Ratio Measurement, with ports shorted. Performance is Characteristic.

Frequency Range	Magnitude (dB/°C)	Phase (degree/°C)
0.07 to 0.01 MHz	<0.04	<0.4
0.01 to 2.5 GHz	< 0.03	< 0.4
2.5 to 20 GHz	< 0.04	< 0.5
20 to 50 GHz	< 0.06	< 0.8
50 to 65 GHz	< 0.07	< 1.1
65 to 70 GHz	< 0.10	< 1.1

3.5 Phase Noise, Harmonics and Non-Harmonics (Spurious)

Measured at default power. Performance is Characteristic.

Frequency Range	SSB Phase Noise (dBc/Hz) at 10 kHz offset	Harmonics (dBc) (second and third)	Non-Harmonics Spurious (dBc) at >1 kHz offset
0.07 to 0.01 MHz	-78	-20	-20
0.01 to 2.5 GHz	-84	-20	-30
2.5 to 20 GHz	-72	-20*	-30
20 to 40 GHz	-66	-20	-30
40 to 50 GHz	-61	-20	-30
50 to 65 GHz	-61	-20	-30
65 to 70 GHz	-61	-20	-30

* May degrade by 3 dB (typical) between 2.5 and 2.7 GHz

3.6 Uncorrected (Raw) Port Characteristics

Performance is Characteristic.

Frequency Range	Directivity (dB)	Port Match** (dB)
0.07 to 0.01 MHz	>10*	>8
0.01 to 2.5 GHz	>9*	>10
2.5 to 20 GHz	>17	>9
20 to 40 GHz	>15	>7
40 to 50 GHz	>13	>7
50 to 65 GHz	>11	>7
65 to 70 GHz	>8	>7

* <300 kHz and 200 MHz below 2.5 GHz: 4 dB (typical)

** Port Match is defined as the worst of source and load match.

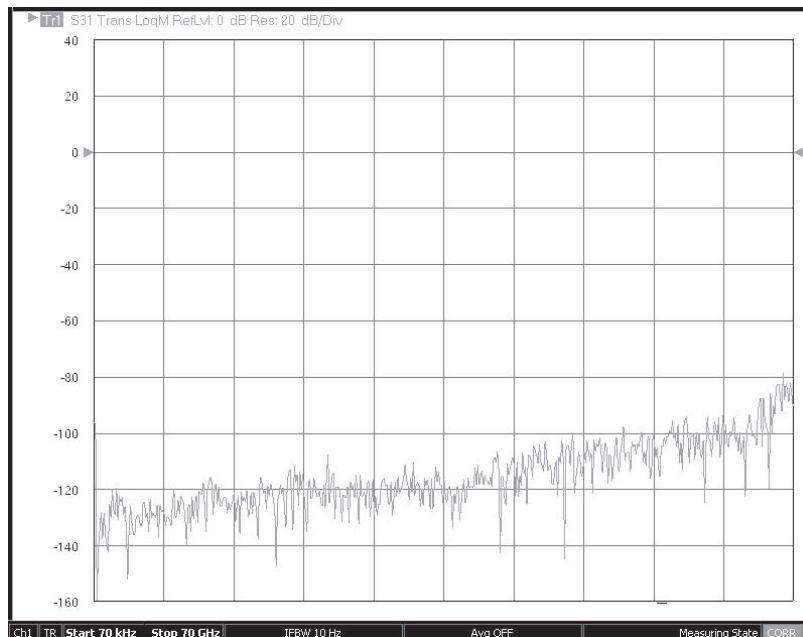

System Dynamic Range (As Measured, not RMS). 10 Hz IF BW, No averaging, at max power. Ports terminated after Transmission Cal.

3.7 Corrected System Performance and Uncertainties

MN4694B with MS4642A or MS4644A, 20 or 40 GHz Models, with full SOLT Cal (3 Thrus), using the 3652A K Cal Kit

Frequency Range (GHz)	Directivity (dB)	Source Match (dB)	Load Match* (dB)	Reflection Tracking (dB)	Transmission Tracking (dB)
< 0.01	> 38	> 36	> 38	±0.02	±0.05
0.01 to 2.5	> 37	> 41	> 37	±0.005	±0.03
2.5 to 20	> 34	> 39	> 35	±0.006	±0.07
20 to 40	> 32	> 34	> 32	±0.006	±0.08

* Since Residual Load Match is limited by Residual Directivity and the user test port cable, it can only be specified as Residual Directivity. For practical considerations, derate it by ~ 8 dB for a 3670 series test port cable, to compensate for effects such as match, repeatability, bend radius, etc.

Measurement Uncertainties

The graphs give measurement uncertainties after the above calibration. The errors are worse case contribution of residual directivity, load and source match, frequency response and isolation, network analyzer dynamic accuracy, and connector repeatability. 10 Hz IF Bandwidth is used. For transmission uncertainties, it is assumed that $s_{11} = s_{22} = 0$. For reflection uncertainties, it is assumed that $s_{21} = s_{12} = 0$. All calibrations and measurements were performed at 0 dBm or default port power, whichever is less. For other conditions, please use our free Exact Uncertainty Calculator software, down-loadable from the Anritsu website at, www.us.anritsu.com.

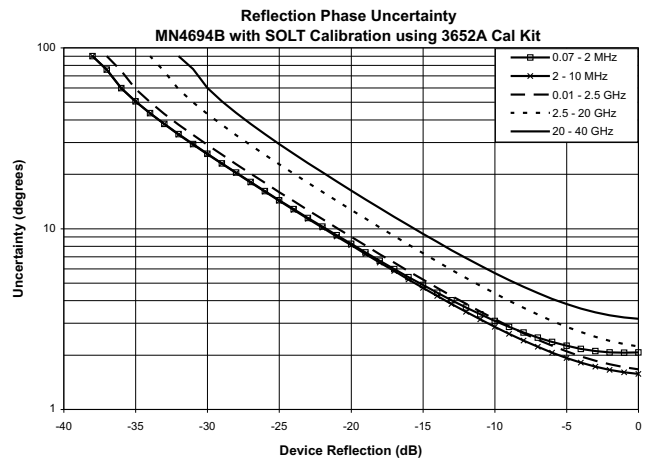
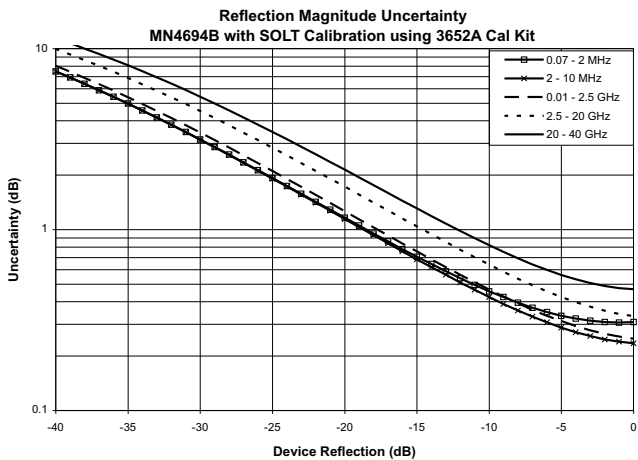
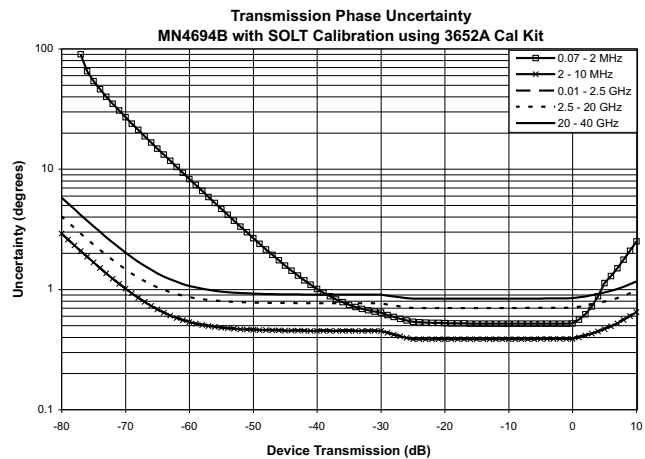
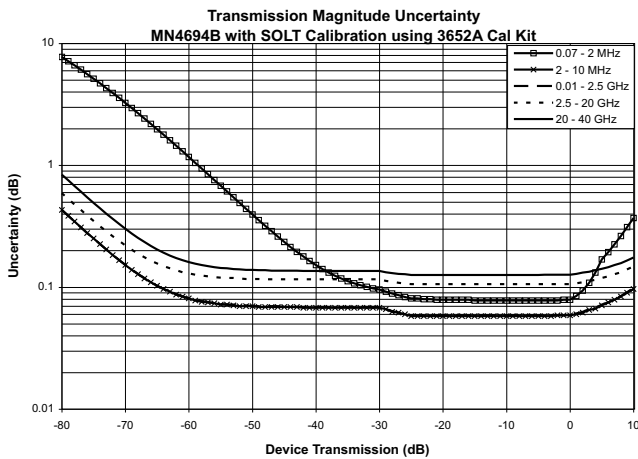

MN4694B with MS4642A or MS4644A, 20 or 40 GHz Models, with full Cal using two Precision AutoCal steps and an external Thru, using the 36585K K AutoCal

Frequency Range (GHz)	Directivity (dB)	Source Match (dB)	Load Match* (dB)	Reflection Tracking (dB)	Transmission Tracking (dB)
<0.01**	> 40	> 40	>43	±0.10	±0.10
0.01 to 2.5	> 43	> 47	> 43	±0.05	±0.03
2.5 to 20	> 50	> 47	> 50	±0.09	±0.03
20 to 40	> 48	> 47	> 48	±0.14	±0.07

* Since Residual Load Match is limited by Residual Directivity and the user test port cable, it can only be specified as Residual Directivity. For practical considerations, derate it by ~ 8 dB for a 3670 series test port cable, to compensate for effects such as match, repeatability, bend radius, etc.
 ** Typical performance below 2 MHz

Measurement Uncertainties

The graphs give measurement uncertainties after the above calibration. The errors are worse case contribution of residual directivity, load and source match, frequency response and isolation, network analyzer dynamic accuracy, and connector repeatability. 10 Hz IF Bandwidth is used. For transmission uncertainties, it is assumed that $s_{11} = s_{22} = 0$. For reflection uncertainties, it is assumed that $s_{21} = s_{12} = 0$. All calibrations and measurements were performed at 0 dBm or default port power, whichever is less. For other conditions, please use our free Exact Uncertainty Calculator software, down-loadable from the Anritsu website at, www.us.anritsu.com.

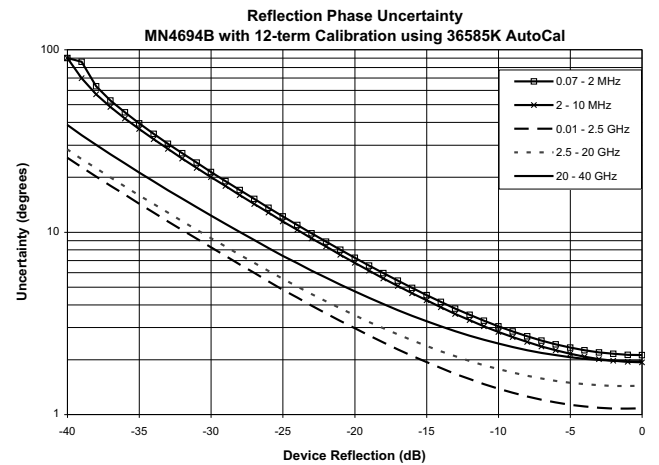
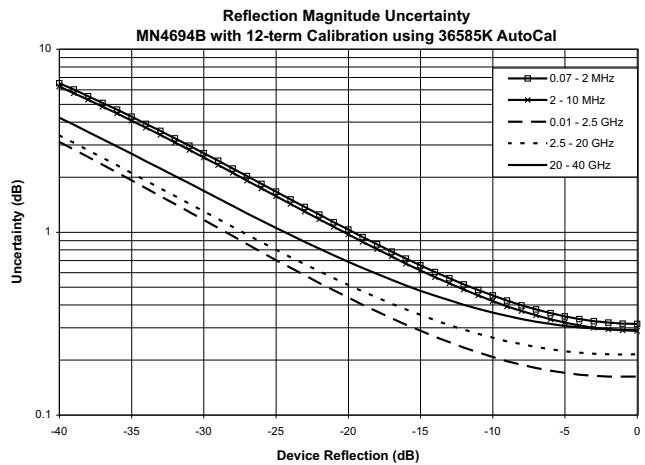
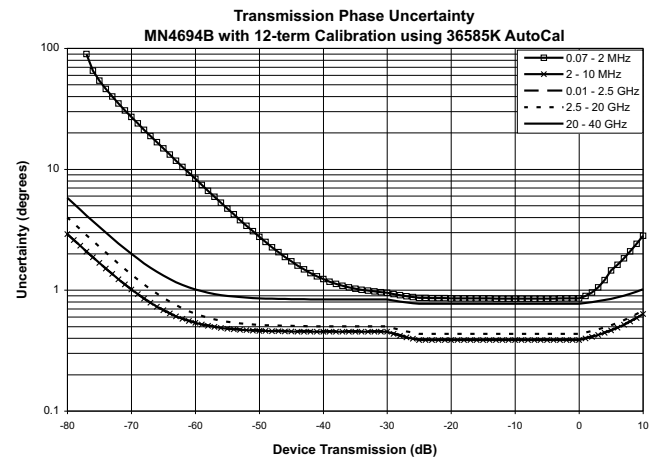
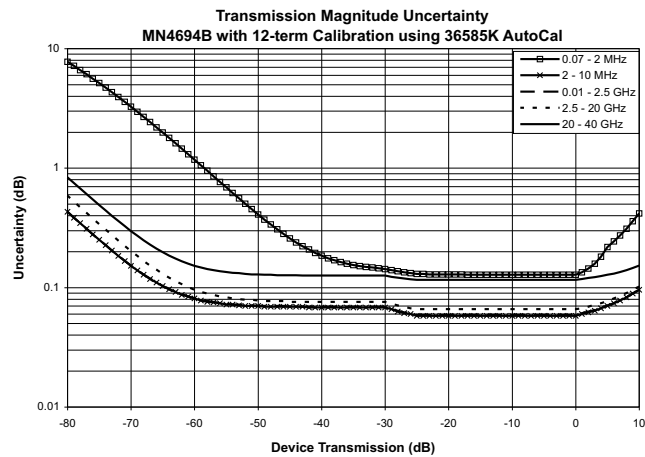

MN4697B with MS4645A or MS4647A, 50 or 70 GHz Models, with full SOLT Cal (3 Thrus), using the 3654D V Cal Kit

Frequency Range (GHz)	Directivity (dB)	Source Match (dB)	Load Match* (dB)	Reflection Tracking (dB)	Transmission Tracking (dB)
< 0.01	>38	>36	>38	±0.02	±0.05
0.01 to 2.5	> 40	> 39	> 40	±0.02	±0.05
2.5 to 20	> 40	> 37	> 40	±0.02	±0.07
20 to 40	> 35	> 32	> 35	±0.02	±0.08
40 to 65	> 32	> 28	> 32	±0.08	±0.12
65 to 67	> 32	> 28	> 32	±0.15	±0.15
67 to 70	> 28	>26	> 28	±0.30	±0.15

* Since Residual Load Match is limited by Residual Directivity and the user test port cable, it can only be specified as Residual Directivity. For practical considerations, derate it by ~ 8 dB for a 3670 series test port cable, to compensate for effects such as match, repeatability, bend radius, etc.

Measurement Uncertainties

The graphs give measurement uncertainties after the above calibration. The errors are worst case contribution of residual directivity, load and source match, frequency response and isolation, network analyzer dynamic accuracy, and connector repeatability. 10 Hz IF Bandwidth is used. For transmission uncertainties, it is assumed that $s_{11} = s_{22} = 0$. For reflection uncertainties, it is assumed that $s_{21} = s_{12} = 0$. All calibrations and measurements were performed at 0 dBm or default port power, whichever is less. For other conditions, please use our free Exact Uncertainty Calculator software, down-loadable from the Anritsu website at, www.us.anritsu.com.

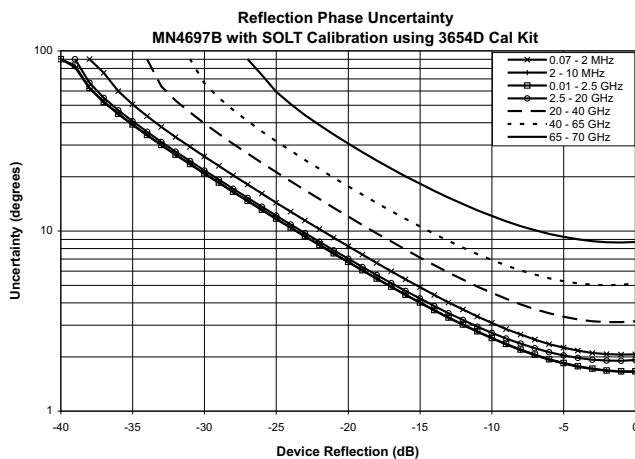
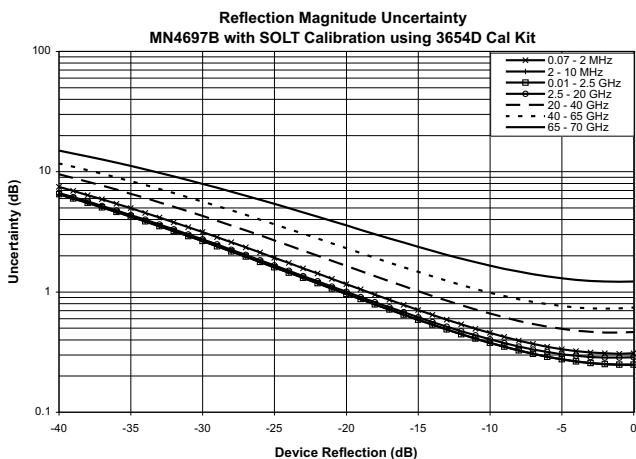
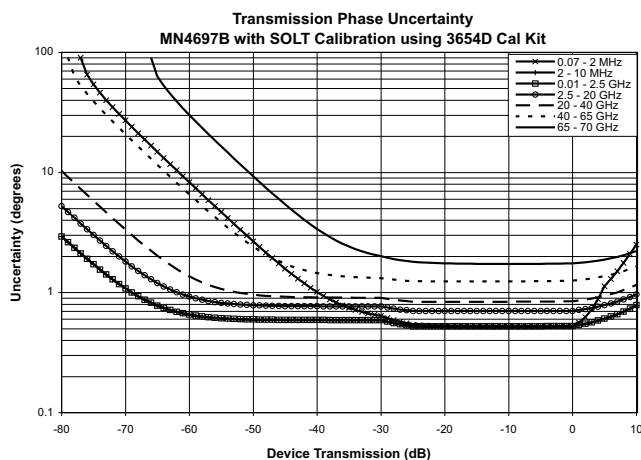
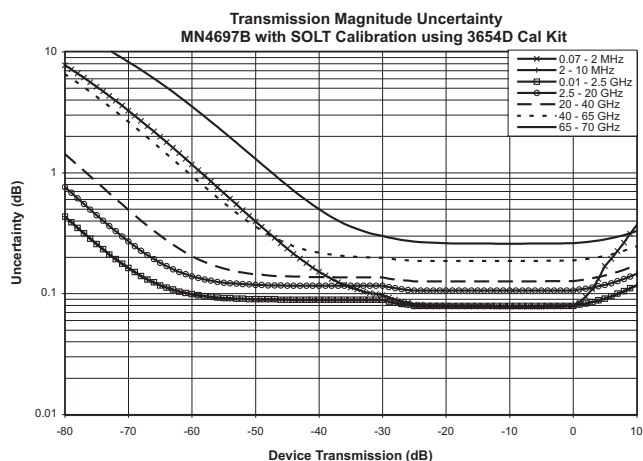

MN4697B with MS4645A or MS4647A, 50 or 70 GHz Models, with full Cal, using two Precision AutoCal steps and an external Thru, using the 36585V V AutoCal

Frequency Range (GHz)	Directivity (dB)	Source Match (dB)	Load Match* (dB)	Reflection Tracking (dB)	Transmission Tracking (dB)
< 0.01**	> 40	> 40	> 40	±0.10	±0.10
0.01 to 2.5	> 43	> 47	> 43	±0.05	±0.03
2.5 to 20	> 50	> 47	> 50	±0.09	±0.03
20 to 40	> 48	> 47	> 48	±0.14	±0.07
40 to 65	> 43	> 45	> 43	±0.17***	±0.10
65 to 67	> 43	> 45	> 43	±0.17	±0.10
67 to 70	> 42	>40	> 42	±0.30	±0.12

* Since Residual Load Match is limited by Residual Directivity and the user test port cable, it can only be specified as Residual Directivity.
 For practical considerations, derate it by ~ 8 dB for a 3670 series test port cable, to compensate for effects such as match, repeatability, bend radius, etc.
 ** Typical performance below 2 MHz
 *** ±0.25 dB between 51-55 GHz

Measurement Uncertainties

The graphs give measurement uncertainties after the above calibration. The errors are worse case contribution of residual directivity, load and source match, frequency response and isolation, network analyzer dynamic accuracy, and connector repeatability. 10 Hz IF Bandwidth is used. For transmission uncertainties, it is assumed that $s_{11} = s_{22} = 0$. For reflection uncertainties, it is assumed that $s_{21} = s_{12} = 0$. All calibrations and measurements were performed at 0 dBm or default port power, whichever is less. For other conditions, please use our free Exact Uncertainty Calculator software, down-loadable from the Anritsu website at, www.us.anritsu.com.

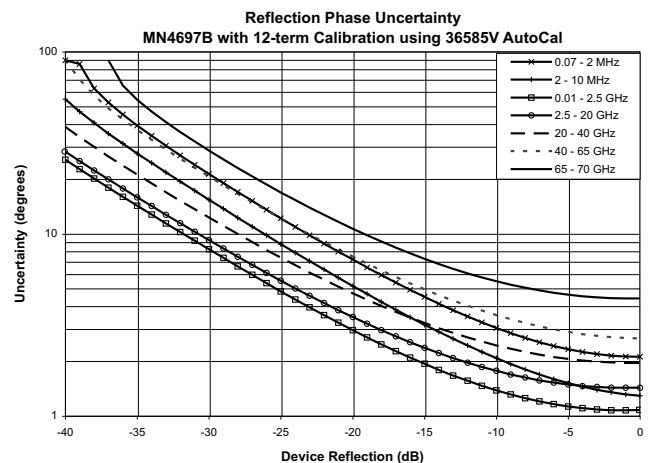
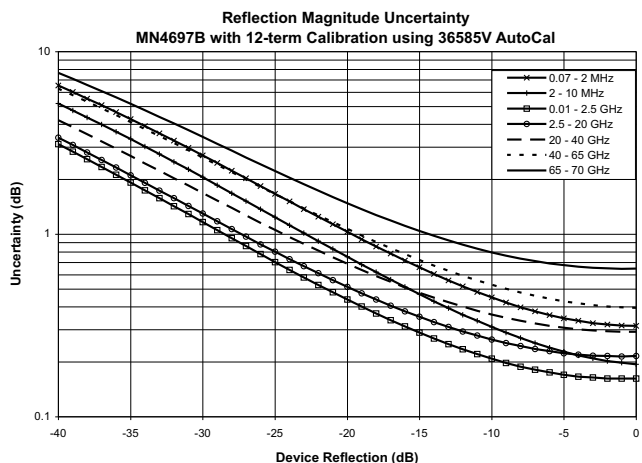
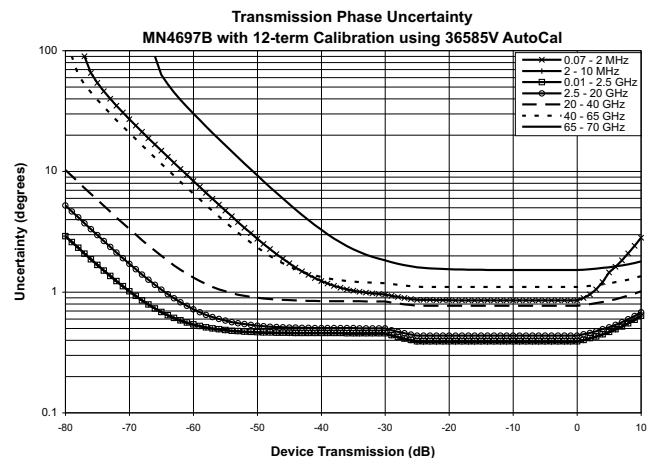
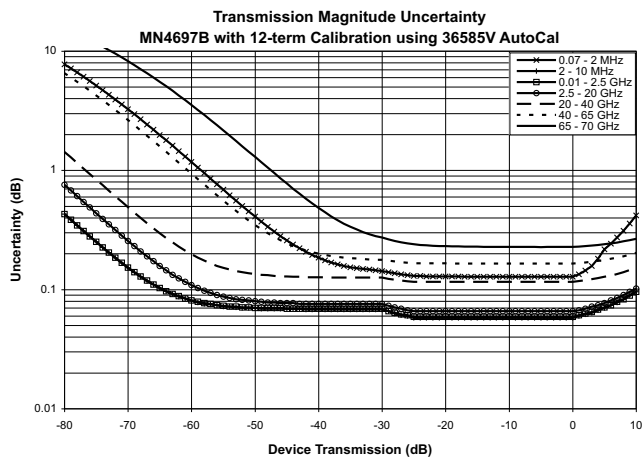

3.8 Measurement Time

Measurement Time (ms), SYNTHESIZED sweep, Display ON, ALC ON

Calibration	Sweep Width	IF BW	401 points	1,601 points	25,001 points
4-port Calibration (per sweep)	Wide (70 GHz Span)	1 MHz	50	70	700
		30 kHz	67	120	1,300
		1 kHz	420	1,500	25,000

4. Remote Operability

Check the base MS4640A VNA data sheet for remote operability. The 4-port system is controllable via GPIB, LAN, USB, through the base VNA. The test set itself is controlled via GPIB by the base VNA, and not intended to be controlled directly by the user.

5. Capabilities and Calibrations added to the base 2-port VNA

When the VNA application detects an MN469xB series test set on its GPIB bus upon loading, it automatically goes into 4-port mode, making available the following capabilities.

Measurement Parameters	16 single-ended S-parameters, and any user-defined combination of a_{1-4} , b_{1-4} , and 16 mixed-mode S-parameters (DD, CC, DC, CD); Uses the superposition technique; Ideal and highly accurate for linear devices and measurements
Correction Models	Using 2-port Precision AutoCal <ul style="list-style-type: none"> • 1-port Cals (Ports 1-4) • 2-port Cals (Single, Double, Full, 1 path 2 ports) • 4-port Cals (uses two AutoCal steps and up to 4 external Thru/Reciprocal, minimum of 1) Using standard Cal Kits <ul style="list-style-type: none"> • Transmission Frequency Response (between any 2 ports, any direction) • Reflection Frequency Response, Ports 1-4 • 1-port Cals (Ports 1-4) • 2-port Cals (Single, Double, Full, 1 path 2 ports) • 3-port Cals (uses one Full 2-port Cal, one Full 1-port Cal, and up to 2 additional Thru/Reciprocal, minimum of 1) • 4-port Cals (uses two Full 2-port Cals and up to 4 additional Thru/Reciprocal, minimum of 1)
Calibration Methods	All existing Calibrations Methods are available: SOLT, SSLT, SSST, SOLR, SSLR, SSSR, LRL, LRM, A-LRM, with one exception that LRL, LRM, and Reciprocal cannot be used for ports 1-2, and 3-4 combinations, when using the external 4-port test set.
Bias Tees	Bias tees are available in the source path of each port. 4 each. 0.4 A max., 40 VDC 3 kHz BW (nominal), looking into a High Impedance 10 Mohms to Ground for Static Discharge Protection Located at rear panel

7. Front Panel Connections

Test Ports 1, 2, 3, and 4	Universal test port connectors, easily exchangeable in case of damage K (male) for MN4694B V (male) for MN4697B Damage Input Levels: +20 dBm max, 40 VDC max.
Source Inputs from VNA	Inputs from VNA Test Ports 1 and 2, 2 each K (female) for MN4694B V (female) for MN4697B B Reference Outputs to VNA
(High Band)	Outputs to VNA Front Panel high band b1 (in) and b2 (in), 2 each K (female) for MN4694B V (female) for MN4697B



MN469xB Test Set Front Panel and connections to base VNA

8. Rear Panel Connections

B Reference Outputs to VNA (Low Band)	Outputs to VNA Rear Panel low band b1 (in) and b2 (in), 2 each SMA (female)
Bias Inputs	J1-J4 for Ports 1-4 respectively, BNC (female), 4 each + fuses
GPIB Port	Type D-24, female, IEEE 488.2 compatible (Controllable only by the base VNA)
AC Power Input	AC Input Connector, fused (250 V, 2 A) 150 VA max., 85-240 VAC, 47-63 Hz



MN469xB Test Set Rear Panel and connections to base VNA.

9. Mechanical and Environmental

Dimensions	Height	134 mm (3u) 153 mm between feet outer edges
	Width	426 mm body 457 mm between feet outer edges 487 mm between
	Depth	450 mm body 540 mm between handle and foot outer edges
Weight	Fully Loaded	< 10 kg
Environmental (Operating)	Conforms to MIL-PRF-28800F (class 3)	
	Temperature Range	0 °C to +50 °C without error codes*
	Relative Humidity	5% to 95% at +40 °C
	Altitude	4,600 m
Environmental (Non-operating)	Temperature Range	-40 °C to +75 °C
	Relative Humidity	0% to 90% at +65 °C (non-condensing)
	Altitude	15,200 m
EMI	Meets the emissions and immunity requirements of: EN55011/1991 Class A/CISPR-11 Class A EN50082-1/1993 IEC 801-2/1984 (4 kV CD, 8 kV AD) IEC 1000-4-3/1995 (3 V/m, 80-1000 MHz) IEC 801-4/1988 (500 V SL, 1000 V PL) IEC 1000-4-5/1995 (2 kV L-E, 1 kV L-L)	

10. Warranty

1 year warranty is standard on the MN469xB series test sets. Additional warranty available.

11. Ordering Information

Test Set Models

Part Number	Description	More Information
MN4694B	4-port Test Set, K For use with MS4642A* for 70 MHz** to 20 GHz Coverage For use with MS4644A* for 70 MHz** to 40 GHz Coverage	Includes: - Interface cables to base VNA (8 each) - GPIB cable to base VNA - Power Cord - Installation Instructions (Manuals covered in base VNA manuals.)
MN4697B	4-port Test Set, V For use with MS4645A* for 70 MHz** to 50 GHz Coverage For use with MS4647A* for 70 MHz** to 70 GHz Coverage	

* Base VNA must include the optional direct access loops, available with option 051 or 06x.

** Operational to 4 kHz; Requires Base VNA to include Option 070, otherwise cannot be operated below 10 MHz.

For accessories such as calibration solutions, test port cables please refer to the base VNA data sheet and configuration guide. All calibrations kits available for the 2-port VNA are usable with the 4-port solution, including the 2-port Precision AutoCal. The Verification Kits available only support the verification of the 2-port base VNA.

12. Configuration Guide

Minimum 20 GHz 4-port System Configuration (10 MHz to 20 GHz)

Part Number	Description	More Information
MS4642A	VectorStar 2-port VNA, 10 MHz to 20 GHz	
MS4642A-051	Adds Direct Access Loops to base MS4642A VNA	Additional Options Available
MN4694B	4-port Test Set, K	

Additional items that may be needed:

Part Number	Description	More Information
MS4640A-070	70 kHz Low-end on base VNA	Allows 4-port measurements to 70 kHz, operational to 40 kHz
3670K50-1	Test Port Cable, 30 cm, K m-f (4 pieces recommended)	Other types exist.
36585K Series	Precision AutoCal 2-port, K	Different connector variations exist.
3650A	Cal Kit, SMA/3.5 mm connector	Different variations exist.
33SS50	Adapter, Precision, 3.5 mm male to 3.5 mm male	Phase Equal Series; As many as needed
33SFSF50	Adapter, Precision, 3.5 mm female to 3.5 mm female	Phase Equal Series; As many as needed
33SSF50	Adapter, Precision, 3.5 mm male to 3.5 mm female	Phase Equal Series; As many as needed

Minimum 40 GHz 4-port System Configuration (10 MHz to 40 GHz)

Part Number	Description	More Information
MS4644A	VectorStar 2-port VNA, 10 MHz to 40 GHz	
MS4644A-051	Adds Direct Access Loops to base MS4644A VNA	Additional Options Available
MN4694B	4-port Test Set, K	

Additional items that may be needed:

Part Number	Description	More Information
MS4640A-070	70 kHz Low-end on base VNA	Allows 4-port measurements to 70 kHz, operational to 40 kHz
3670K50-1	Test Port Cable, 30 cm, K m-f (4 pieces recommended)	Other types exist.
36585K Series	Precision AutoCal 2-port, K	Different connector variations exist.
3652A	Cal Kit, K connector	Different variations exist.
33KK50	Adapter, Precision, K male to K male	Phase Equal Series; As many as needed
33KFKF50	Adapter, Precision, K female to K female	Phase Equal Series; As many as needed
33KKF50	Adapter, Precision, K male to K female	Phase Equal Series; As many as needed

Minimum 50 GHz 4-port System Configuration (10 MHz to 50 GHz)

Part Number	Description	More Information
MS4645A	VectorStar 2-port VNA, 10 MHz to 50 GHz	
MS4645A-051	Adds Direct Access Loops to base MS4645A VNA	Additional Options Available
MN4697B	4-port Test Set, V	

Additional items that may be needed:

Part Number	Description	More Information
MS4640A-070	70 kHz Low-end on base VNA	Allows 4-port measurements to 70 kHz, operational to 40 kHz
3670V50A-1	Test Port Cable, 30 cm, V m-f (4 pieces recommended)	Other types exist.
36585V Series	Precision AutoCal 2-port, V	Different connector variations exist.
3654D	Cal Kit, V connector	Different variations exist.
33VV50C	Adapter, Precision, V male to V male	Phase Equal Series; As many as needed
33VVF50C	Adapter, Precision, V female to V female	Phase Equal Series; As many as needed
33VVF50C	Adapter, Precision, V male to V female	Phase Equal Series; As many as needed

Minimum 70 GHz 4-port System Configuration (10 MHz to 70 GHz)

Part Number	Description	More Information
MS4647A	VectorStar 2-port VNA, 10 MHz to 70 GHz	
MS4647A-051	Adds Direct Access Loops to base MS4647A VNA	Additional Options Available
MN4697B	4-port Test Set, V	

Additional items that may be needed:

Part Number	Description	More Information
MS4640A-070	70 kHz Low-end on base VNA	Allows 4-port measurements to 70 kHz, operational to 40 kHz
3670V50A-1	Test Port Cable, 30 cm, V m-f (4 pieces recommended)	Other types exist.
36585V Series	Precision AutoCal 2-port, V	Different connector variations exist.
3654D	Cal Kit, V connector	Different variations exist.
33VV50C	Adapter, Precision, V male to V male	Phase Equal Series; As many as needed
33VVF50C	Adapter, Precision, V female to V female	Phase Equal Series; As many as needed
33VVF50C	Adapter, Precision, V male to V female	Phase Equal Series; As many as needed

Anritsu

Anritsu Corporation

5-1-1 Onna, Atsugi-shi, Kanagawa, 243-8555 Japan
Phone: +81-46-223-1111
Fax: +81-46-296-1264

• U.S.A.

Anritsu Company

1155 East Collins Boulevard, Suite 100,
Richardson, Texas 75081 U.S.A.
Toll Free: 1-800-ANRITSU (267-4878)
Phone: +1-972-644-1777
Fax: +1-972-671-1877

• Canada

Anritsu Electronics Ltd.

700 Silver Seven Road, Suite 120, Kanata,
Ontario K2V 1C3, Canada
Phone: +1-613-591-2003
Fax: +1-613-591-1006

• Brazil

Anritsu Eletrônica Ltda.

Praca Amadeu Amaral, 27-1 Andar
01327-010 - Paraiso, São Paulo, Brazil
Phone: +55-11-3283-2511
Fax: +55-11-3886940

• Mexico

Anritsu Company, S.A. de C.V.
Av. Ejército Nacional No. 579 Piso 9, Col. Granada
11520 México, D.F., México
Phone: +52-55-1101-2370
Fax: +52-55-5254-3147

• U.K.

Anritsu EMEA Ltd.

200 Capability Green, Luton, Bedfordshire LU1 3LU, U.K.
Phone: +44-1582-433200
Fax: +44-1582-731303

• France

Anritsu S.A.

16/18 Avenue du Québec-SILIC 720
91961 COURTABOEUF CEDEX, France
Phone: +33-1-60-92-15-50
Fax: +33-1-64-46-10-65

• Germany

Anritsu GmbH

Nemetschek Haus, Konrad-Zuse-Platz 1
81829 München, Germany
Phone: +49 (0) 89 442308-0
Fax: +49 (0) 89 442308-55

• Italy

Anritsu S.p.A.

Via Elio Vittorini, 129, 00144 Roma, Italy
Phone: +39-06-509-9711
Fax: +39-06-502-2425

• Sweden

Anritsu AB

Borgarfjordsgatan 13, 164 40 Kista, Sweden
Phone: +46-8-534-707-00
Fax: +46-8-534-707-30

• Finland

Anritsu AB

Teknobulevardi 3-5, FI-01530 Vantaa, Finland
Phone: +358-20-741-8100
Fax: +358-20-741-8111

• Denmark

Anritsu A/S

Kirkebjerg Allé 90 DK-2605 Brøndby, Denmark
Phone: +45-72112200
Fax: +45-72112210

• Spain

Anritsu EMEA Ltd.

Oficina de Representación en España

Edificio Veganova
Avda de la Vega, nº 1 (edf 8, pl1, of 8)
28108 ALCOBENDAS - Madrid, Spain
Phone: +34-914905761
Fax: +34-914905762

• Russia

Anritsu EMEA Ltd.

Representation Office in Russia

Tverskaya str. 16/2, bld. 1, 7th floor.
Russia, 125009, Moscow
Phone: +7-495-363-1694
Fax: +7-495-935-8962

• United Arab Emirates

Anritsu EMEA Ltd.

Dubai Liaison Office

P O Box 500413 - Dubai Internet City
Al Thuraya Building, Tower 1, Suite 701, 7th Floor
Dubai, United Arab Emirates
Phone: +971-4-3670352
Fax: +971-4-3688460

• Singapore

Anritsu Pte. Ltd.

60 Alexandra Terrace, #02-08, The Comtech (Lobby A)
Singapore 118502
Phone: +65-6282-2400
Fax: +65-6282-2533

• India

Anritsu Pte. Ltd.

India Branch Office

3rd Floor, Shri Lakshminarayan Niwas,
#2726, 80 ft Road, HAL 3rd Stage, Bangalore - 560 075, India
Phone: +91-80-4058-1300
Fax: +91-80-4058-1301

• P. R. China (Hong Kong)

Anritsu Company Ltd.

Units 4 & 5, 28th Floor, Greenfield Tower, Concordia Plaza,
No. 1 Science Museum Road, Tsim Sha Tsui East,
Kowloon, Hong Kong, P.R. China
Phone: +852-2301-4980
Fax: +852-2301-3545

• P. R. China (Beijing)

Anritsu Company Ltd.

Beijing Representative Office

Room 2008, Beijing Fortune Building,
No. 5, Dong-San-Huan Bei Road,
Chao-Yang District, Beijing 100004, P.R. China
Phone: +86-10-6590-9230
Fax: +86-10-6590-9235

• Korea

Anritsu Corporation, Ltd.

8F Hyunjuk Bldg, 832-41, Yeoksam-Dong,
Kangnam-ku, Seoul, 135-080, Korea
Phone: +82-2-553-6603
Fax: +82-2-553-6604

• Australia

Anritsu Pty Ltd.

Unit 21/270 Ferntree Gully Road, Notting Hill
Victoria, 3168, Australia
Phone: +61-3-9558-8177
Fax: +61-3-9558-8255

• Taiwan

Anritsu Company Inc.

7F, No. 316, Sec. 1, Neihu Rd., Taipei 114, Taiwan
Phone: +886-2-8751-1816
Fax: +886-2-8751-1817

